

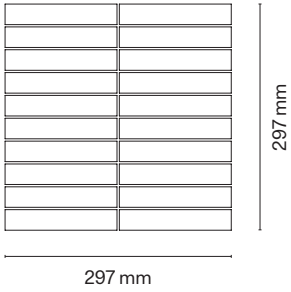

LISTELLO

MESH MOUNTED



FORMATO / Size



3×15 cm
1 $\frac{1}{8}$ "×6"

CONFIGURAZIONI / Configurations



ROSATO



MATTONE



AMARANTO



CARBONE

SUPERFICIE Surface	MATTE R10 – Floor / Wall	MATTE R10 – Floor / Wall	MATTE R10 – Floor / Wall	MATTE R10 – Floor / Wall
FORMATO Size	30×30 cm 11 $\frac{1}{8}$ "×11 $\frac{1}{8}$ "	30×30 cm 11 $\frac{1}{8}$ "×11 $\frac{1}{8}$ "	30×30 cm 11 $\frac{1}{8}$ "×11 $\frac{1}{8}$ "	30×30 cm 11 $\frac{1}{8}$ "×11 $\frac{1}{8}$ "
SPESSORE Thickness	9 mm $\frac{3}{8}$ "	9 mm $\frac{3}{8}$ "	9 mm $\frac{3}{8}$ "	9 mm $\frac{3}{8}$ "
CODICE Code	781828	781829	781830	781831

INTRECCIO

MESH MOUNTED

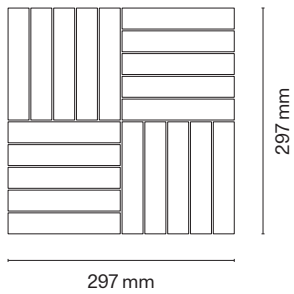

FORMATO / Size



3×15 cm
1¼"×6"

CONFIGURAZIONI / Configurations



COTONE MATTONE



MATTONE COTONE



ROSATO AMARANTO



AMARANTO ROSATO

SUPERFICIE Surface	MATTE R10 – Floor / Wall	MATTE R10 – Floor / Wall	MATTE R10 – Floor / Wall	MATTE R10 – Floor / Wall
FORMATO Size	30×30 cm 11¼"×11¼"	30×30 cm 11¼"×11¼"	30×30 cm 11¼"×11¼"	30×30 cm 11¼"×11¼"
SPESSORE Thickness	9 mm ¾"	9 mm ¾"	9 mm ¾"	9 mm ¾"
CODICE Code	781836	781837	781838	781839

SPINA

MESH MOUNTED

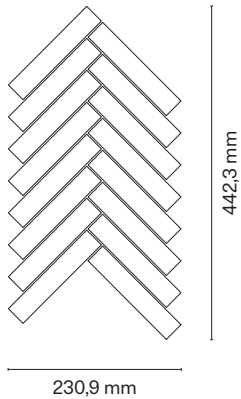

FORMATO / Size



3×15 cm
1 1/8"×6"

CONFIGURAZIONI / Configurations



ROSATO



MATTONE



AMARANTO



CARBONE

SUPERFICIE Surface	MATTE R10 – Floor / Wall	MATTE R10 – Floor / Wall	MATTE R10 – Floor / Wall	MATTE R10 – Floor / Wall
FORMATO Size	23×44 cm 19"×17 1/3"	23×44 cm 19"×17 1/3"	23×44 cm 19"×17 1/3"	23×44 cm 19"×17 1/3"
SPESSORE Thickness	9 mm 3/8"	9 mm 3/8"	9 mm 3/8"	9 mm 3/8"
CODICE Code	781824	781825	781826	781827

TAPPETO

MESH MOUNTED

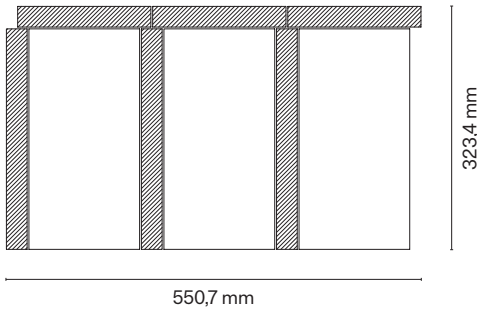

FORMATI / Sizes

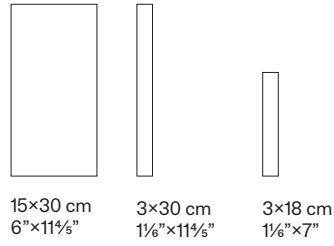

CONFIGURAZIONI / Configurations



COTONE MATTONE



MATTONE COTONE



ROSATO AMARANTO



AMARANTO ROSATO

SUPERFICIE Surface	MATTE R10 — Floor / Wall	MATTE R10 — Floor / Wall	MATTE R10 — Floor / Wall	MATTE R10 — Floor / Wall
FORMATO Size	55×32 cm 21½"×12¾"	55×32 cm 21½"×12¾"	55×32 cm 21½"×12¾"	55×32 cm 21½"×12¾"
SPESSORE Thickness	9 mm ¾"	9 mm ¾"	9 mm ¾"	9 mm ¾"
CODICE Code	781832	781833	781834	781835

CUBO

MESH MOUNTED

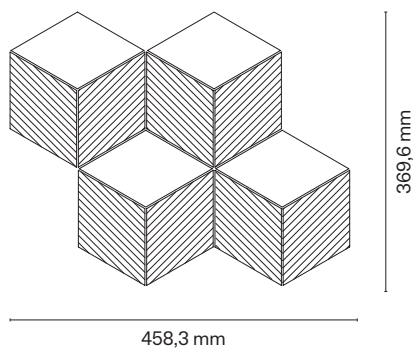

CONFIGURAZIONI / Configurations



COTONE ROSATO MATTONE



ROSATO AMARANTO CARBONE

SUPERFICIE Surface	MATTE R10 – Floor / Wall	MATTE R10 – Floor / Wall
FORMATO Size	37×46 cm 14 ⁴ / ₇ "×18 ¹ / ₈ "	37×46 cm 14 ⁴ / ₇ "×18 ¹ / ₈ "
SPESSORE Thickness	9 mm 3/8"	9 mm 3/8"
CODICE Code	781840	781841

TAVELLA AND LISTELLO

MESH MOUNTED

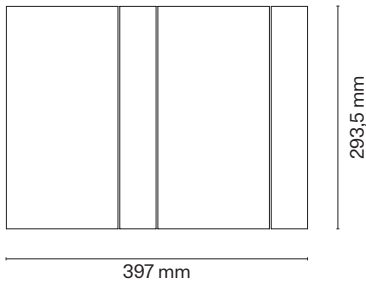

FORMATI / Sizes



15×30 cm
6"×11½"

MATTE



5×30 cm
2"×11½"

MATTE

CONFIGURAZIONI / Configurations



COTONE



MATTONE



AMARANTO



CARBONE

SUPERFICIE Surface	MATTE R10 – Floor / Wall	MATTE R10 – Floor / Wall	MATTE R10 – Floor / Wall	MATTE R10 – Floor / Wall
FORMATO Size	30×40 cm 11½"×15¾"	30×40 cm 11½"×15¾"	30×40 cm 11½"×15¾"	30×40 cm 11½"×15¾"
SPESSORE Thickness	9 mm ¾"	9 mm ¾"	9 mm ¾"	9 mm ¾"
CODICE Code	781816	781817	781818	781819

TAVELLA AND LISTELLO

MESH MOUNTED

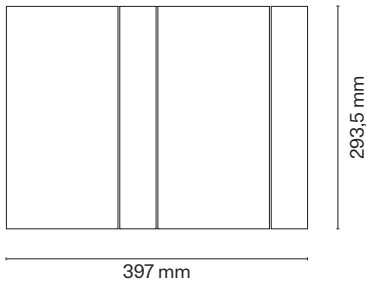

FORMATI / Sizes

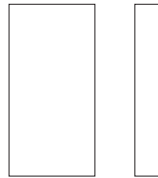

15×30 cm
6"×11½"

5×30 cm
2"×11½"

MATTE

GRANA – GRIP

CONFIGURAZIONI / Configurations



COTONE



MATTONE



AMARANTO



CARBONE

SUPERFICIE Surface	COTONE		MATTONE		AMARANTO		CARBONE	
	MATTE R10 – F/W	GRANA – GRIP R11 – F/W	MATTE R10 – F/W	GRANA – GRIP R11 – F/W	MATTE R10 – F/W	GRANA – GRIP R11 – F/W	MATTE R10 – F/W	GRANA – GRIP R11 – F/W
FORMATO Size	30×40 cm 11½"×15¾"		30×40 cm 11½"×15¾"		30×40 cm 11½"×15¾"		30×40 cm 11½"×15¾"	
SPESSORE Thickness	9 mm ¾"		9 mm ¾"		9 mm ¾"		9 mm ¾"	
CODICE Code	781820		781821		781822		781823	